



Series Catalog



## BESTWARE Hardware Production Co., Ltd.

Add: Block 8, No.6, Jianda Nan Road, Jiangmen, Guangdong, China

Email: [business@bestware-stainless.com](mailto:business@bestware-stainless.com)    [after-sales@bestware-stainless.com](mailto:after-sales@bestware-stainless.com)

WhatsApp: +86 18929047065    Tel: +86 750 3108801

Wechat: +86 18929047065



Website



YouTube



WhatsApp



Wechat

2025 V2.0

Expertise in Stainless Steel

# MANUAL FAUCET

PREMIER SOLUTION PROVIDER OF ONE-STOP STAINLESS COMMERCIAL FAUCETS

[www.bestware-stainless.com](http://www.bestware-stainless.com)

# CONTENTS

## MANUAL FAUCET

---

European Style	01
American Style	05
Economy Style	09
Other Styles	11

### ✓ Product Advantages

Since its establishment, Bestware has always adhered to the principle of "solving industry pain points through product selling points", creating more value for customers. Below is an overview of our unique selling points.



Metering Faucet



Pain Points	Selling Points
Brass contains lead, corrosive, relatively soft, unsuitable for high-frequency commercial use	Food-grade SUS304 (unless otherwise specified), lead free, durable, 100% recyclable, ideal for commercial and sustainable use
Brass valve cores, poor wear resistance, easy to leak, short lifespan	Industry-first stainless steel valve core, wear-resistant, leak-resistant, long lifespan
Low assembly precision, poor component compatibility, short lifespan	High-precision manufacturing, high component compatibility, long lifespan
Complex and unstable installation structures reduce efficiency, high labor cost	Pioneering union joint structure, stable durability and easy, efficient installation, low labor cost
Brass has low hardness and thin material thickness, prone to bursting under pressure	Stainless steel offers twice the hardness of brass, twice the thickness of industry-standard, superior pressure-resistance
Generic aerators offer poor water-saving performance and cause heavy splashing	Neoperl-brand aerator ensures effective water saving with smooth, splash-free flow

### ✓ Our Commitments

- 97%+** Product Satisfaction Upon Receipt by Customers
- 100%** 304/316 Stainless Steel (Unless Specified Otherwise)
- 100%** Product Qualification Rate at Factory Shipment
- 100%** Customer Complaint Resolution Rate



**Take Bestware for a spin, and it'll be your go-to forever!**

## MANUAL FAUCET

EXPERTISE IN STAINLESS STEEL  
**BESTWARE**  
 ONE-STOP SOLUTION PROVIDER OF STAINLESS COMMERCIAL FAUCETS

Key Parts	Features
Material	SUS304
Aerator	Neoperl Brand, Provides Excellent Water Control, Prevents Splashing
Valve Core Material	SUS304 Slow-opening Valve Core
Valve Core Lifespan	Up to 200,000+ Cycles



EXPERTISE IN STAINLESS STEEL  
**BESTWARE**  
 ONE-STOP SOLUTION PROVIDER OF STAINLESS COMMERCIAL FAUCETS

## EUROPEAN STYLE

**100%**  
**SUS304**  
 WETTED PARTS

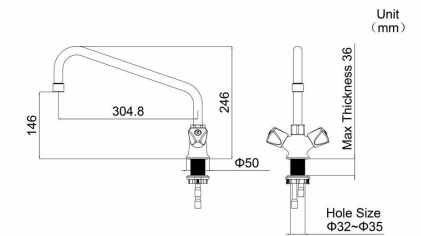

**EF112S**  
 Deck Mount Manual Faucet

Attributes	Details
Swing Nozzle	12"(304.8 mm)
Neoperl Aerator Water Flow	Available in 2.11 GPM (8 LPM) or 3.96 GPM (15 LPM) Options
Temperature Control	Dual-handles Dual-control Hot and Cold Adjustment
Hole Size	Φ32-35 mm

## EUROPEAN STYLE

EXPERTISE IN STAINLESS STEEL

# BESTWARE

ONE-STOP SOLUTION PROVIDER OF STAINLESS COMMERCIAL FAUCETS

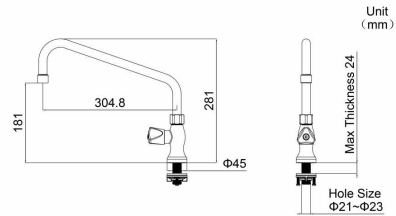

### ES112S

Deck Mount Manual Faucet

Attributes	Details
Swing Nozzle	12"(304.8 mm)
Neoperl Aerator Water Flow	Available in 2.11 GPM (8 LPM) or 3.96 GPM (15 LPM) Options
Temperature Control	Single-handle Single-control Cold Water Only
Hole Size	Φ21-23 mm

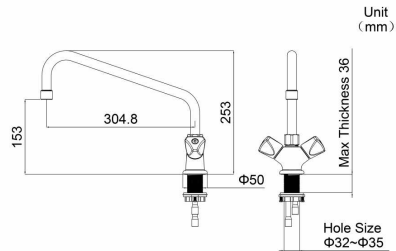

### ED112S

Deck Mount Manual Faucet

Attributes	Details
Swing Nozzle	12"(304.8 mm)
Neoperl Aerator Water Flow	Available in 2.11 GPM (8 LPM) or 3.96 GPM (15 LPM) Options
Temperature Control	Dual-handles Dual-control Hot and Cold Adjustment
Hole Size	Φ32-35 mm

EXPERTISE IN STAINLESS STEEL

# BESTWARE

ONE-STOP SOLUTION PROVIDER OF STAINLESS COMMERCIAL FAUCETS

## EUROPEAN STYLE

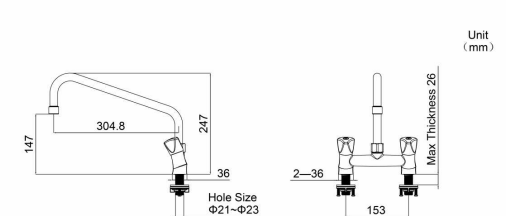

### EH112S

Dual Deck Mount Manual Faucet

Attributes	Details
Swing Nozzle	12"(304.8 mm)
Neoperl Aerator Water Flow	Available in 2.11 GPM (8 LPM) or 3.96 GPM (15 LPM) Options
Temperature Control	Dual-handles Dual-control Hot and Cold Adjustment
Hole Size	Φ21-23 mm, Hole-to-hole Dimension 6"(153 mm)

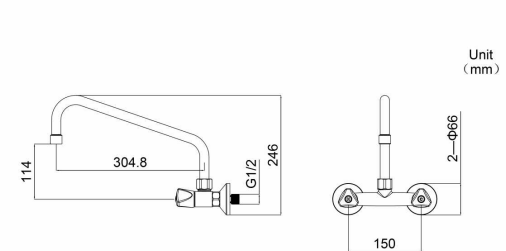

### EW112S

Wall Mount Manual Faucet

Attributes	Details
Swing Nozzle	12"(304.8 mm)
Neoperl Aerator Water Flow	Available in 2.11 GPM (8 LPM) or 3.96 GPM (15 LPM) Options
Temperature Control	Dual-handles Dual-control Hot and Cold Adjustment
Hole Size	G1/2, Hole-to-hole Dimension 5.91"(150 mm)

# MANUAL FAUCET

EXPERTISE IN STAINLESS STEEL  
**BESTWARE**  
 ONE-STOP SOLUTION PROVIDER OF STAINLESS COMMERCIAL FAUCETS

Key Parts	Features
Material	SUS304
Aerator	Neoperl Brand, Provides Excellent Water Control, Prevents Splashing
Valve Core Material	SUS304 Rapid Screw Valve Core
Valve Core Lifespan	Up to 200,000+ Cycles



EXPERTISE IN STAINLESS STEEL  
**BESTWARE**  
 ONE-STOP SOLUTION PROVIDER OF STAINLESS COMMERCIAL FAUCETS

# AMERICAN STYLE

**100%**  
**SUS304**  
 WETTED PARTS

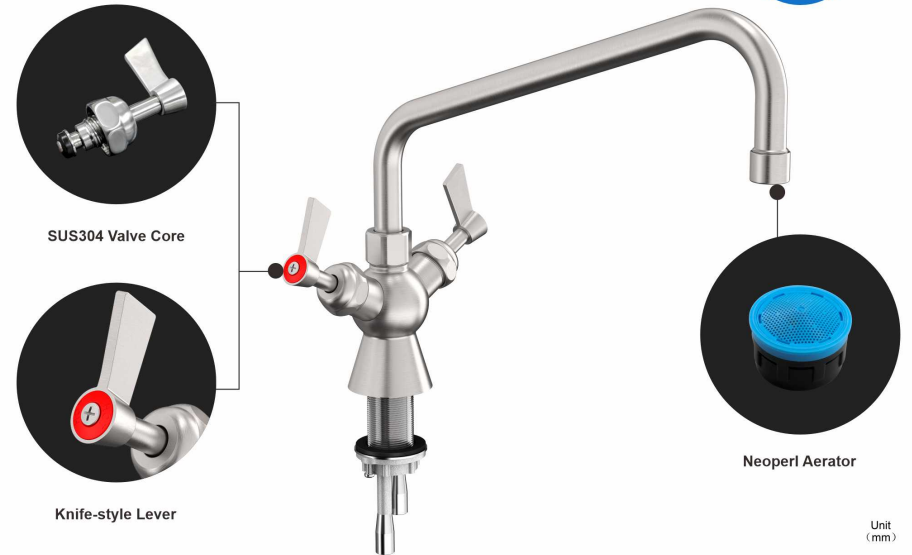

**AA112S**  
 Deck Mount Manual Faucet

Attributes	Details
Swing Nozzle	12"(304.8 mm)
Neoperl Aerator Water Flow	Available in 2.11 GPM (8 LPM) or 3.96 GPM (15 LPM) Options
Temperature Control	Dual-handles Dual-control Hot and Cold Adjustment
Hole Size	Φ32-35 mm

## AMERICAN STYLE

EXPERTISE IN STAINLESS STEEL

# BESTWARE

ONE-STOP SOLUTION PROVIDER OF STAINLESS COMMERCIAL FAUCETS

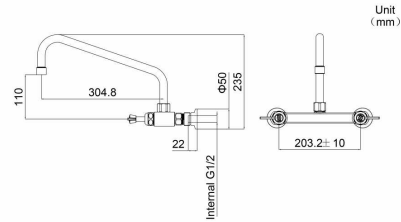
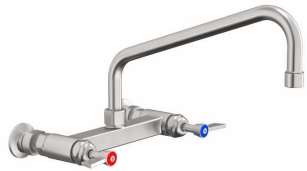

### AW812S

Wall Mount Manual Faucet

Attributes	Details
Swing Nozzle	12"(304.8 mm)
Neoperl Aerator Water Flow	Available in 2.11 GPM (8 LPM) or 3.96 GPM (15 LPM) Options
Temperature Control	Dual-handles Dual-control Hot and Cold Adjustment
Hole Size	G1/2, Hole-to-hole Dimension 8"(203.2±10 mm)

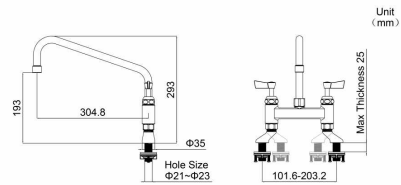

### AD112S

Dual Deck Mount Manual Faucet

Attributes	Details
Swing Nozzle	12"(304.8 mm)
Neoperl Aerator Water Flow	Available in 2.11 GPM (8 LPM) or 3.96 GPM (15 LPM) Options
Temperature Control	Dual-handles Dual-control Hot and Cold Adjustment
Hole Size	Φ21-23 mm, Hole-to-hole Dimension 4"(101.6 mm)-8"(203.2 mm)

EXPERTISE IN STAINLESS STEEL

# BESTWARE

ONE-STOP SOLUTION PROVIDER OF STAINLESS COMMERCIAL FAUCETS

## AMERICAN STYLE

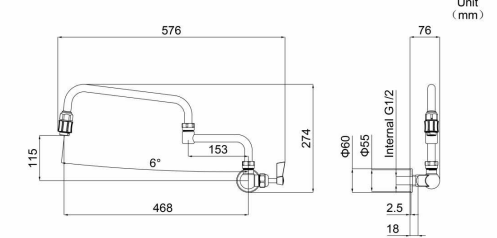

### DJPF-SW

Wall Mount Manual Faucet

Attributes	Details
Swing Nozzle	18.43"(468 mm) Dual-joint Extended Length
Neoperl Flow Straightener	Available in 3.96 GPM (15 LPM)
Temperature Control	Single-handle Single-control Cold Water Only
Hole Size	G1/2

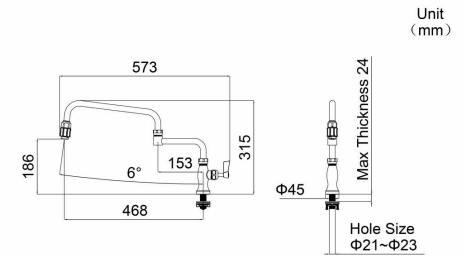

### DJPF-SD

Deck Mount Manual Faucet

Attributes	Details
Swing Nozzle	18.43"(468 mm) Dual-joint Extended Length
Neoperl Flow Straightener	Available in 3.96 GPM (15 LPM)
Temperature Control	Single-handle Single-control Cold Water Only
Hole Size	Φ21-23 mm

## ECONOMY STYLE

EXPERTISE IN STAINLESS STEEL  
**BESTWARE**  
 ONE-STOP SOLUTION PROVIDER OF STAINLESS COMMERCIAL FAUCETS

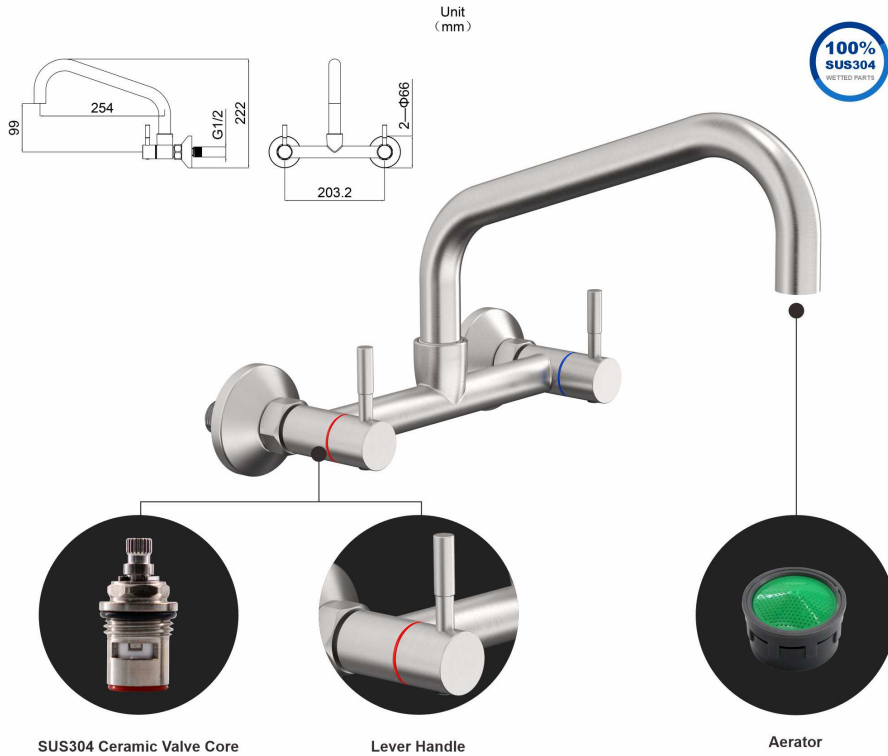

### ECW110S

Wall Mount Manual Faucet

Attributes	Details
Swing Nozzle	10"(254 mm)
Aerator Water Flow	Available in 3.96 GPM (15 LPM)
Temperature Control	Dual-handles Dual-control Hot and Cold Adjustment
Hole Size	G1/2, Hole-to-hole Dimension 8"(203.2 mm)

EXPERTISE IN STAINLESS STEEL  
**BESTWARE**  
 ONE-STOP SOLUTION PROVIDER OF STAINLESS COMMERCIAL FAUCETS

## ECONOMY STYLE

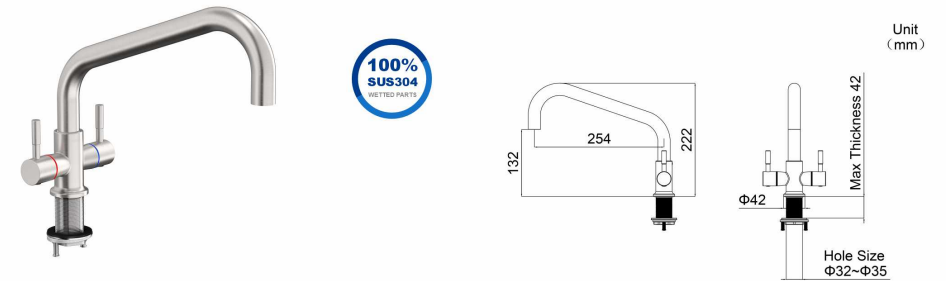

### ECH110S

Deck Mount Manual Faucet

Attributes	Details
Swing Nozzle	10"(254 mm)
Aerator Water Flow	Available in 3.96 GPM (15 LPM)
Temperature Control	Dual-handles Dual-control Hot and Cold Adjustment
Hole Size	Φ32-35 mm

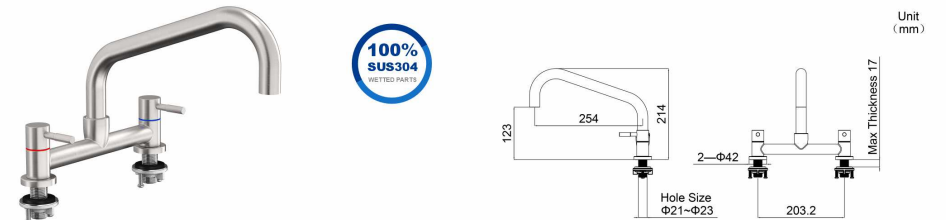

### ECD110S

Dual Deck Mount Manual Faucet

Attributes	Details
Swing Nozzle	10"(254 mm)
Aerator Water Flow	Available in 3.96 GPM (15 LPM)
Temperature Control	Dual-handles Dual-control Hot and Cold Adjustment
Hole Size	Φ21-23 mm, Hole-to-hole Dimension 8"(203.2 mm)

## MANUAL FAUCET

EXPERTISE IN STAINLESS STEEL  
**BESTWARE**  
 ONE-STOP SOLUTION PROVIDER OF STAINLESS COMMERCIAL FAUCETS

Key Parts	Features
Material	SUS304
Aerator	Neoperl Brand, Provides Excellent Water Control, Prevents Splashing
Valve Core Material	Sedal Thermostatic Mixing Valve Core
Valve Core Lifespan	Up to 1,000,000+ Cycles



**100%** SUS304

**Single-handed**

Temperature Control

Easy Operation

EXPERTISE IN STAINLESS STEEL

**BESTWARE**  
 ONE-STOP SOLUTION PROVIDER OF STAINLESS COMMERCIAL FAUCETS

## OTHER STYLES

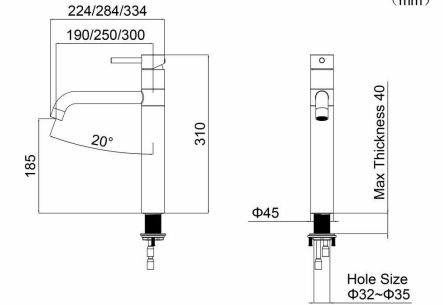

### BTLT190/BTLT250/BTLT300

Deck Mount Manual Faucet

Attributes	Details
Product Size	H=310 mm, L=190/250/300 mm (Optional) Swing Nozzle
Neoperl Aerator Water Flow	Available in 3.96 GPM (15 LPM)
Temperature Control	Single-handle Dual-control Hot and Cold Adjustment
Hole Size	Φ32-35 mm

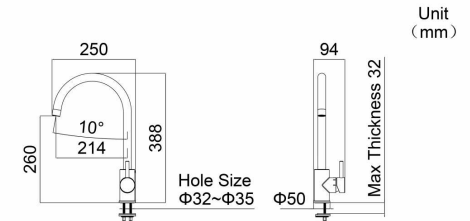

### GSMIX392

Deck Mount Manual Faucet

Attributes	Details
Product Size	H=388 mm, L=214 mm Swing Nozzle
Neoperl Aerator Water Flow	Available in 3.96 GPM (15 LPM)
Temperature Control	Single-handle Dual-control Hot and Cold Adjustment
Hole Size	Φ32-35 mm

## OTHER STYLES

EXPERTISE IN STAINLESS STEEL

# BESTWARE

ONE-STOP SOLUTION PROVIDER OF STAINLESS COMMERCIAL FAUCETS

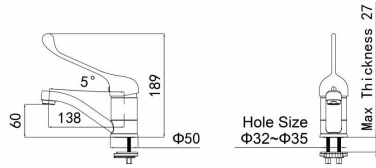

Unit (mm)

## BWLBMIX

Deck Mount Manual Faucet with Extended Lever Handle

Attributes	Details
Swing Nozzle	138 mm
Neoperl Aerator Water Flow	Available in 2.11 GPM (8 LPM) or 3.96 GPM (15 LPM) Options
Temperature Control	Single-handle Dual-control Hot and Cold Adjustment
Hole Size	Φ32-35 mm

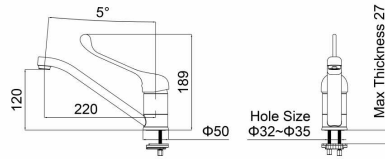

Unit (mm)

## BWLSMIX

Deck Mount Manual Faucet with Extended Lever Handle

Attributes	Details
Swing Nozzle	220 mm
Neoperl Aerator Water Flow	Available in 2.11 GPM (8 LPM) or 3.96 GPM (15 LPM) Options
Temperature Control	Single-handle Dual-control Hot and Cold Adjustment
Hole Size	Φ32-35 mm

EXPERTISE IN STAINLESS STEEL

# BESTWARE

ONE-STOP SOLUTION PROVIDER OF STAINLESS COMMERCIAL FAUCETS

## OTHER STYLES

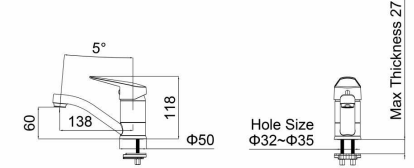

Unit (mm)

## BWBMIX

Deck Mount Manual Faucet with Lever Handle

Attributes	Details
Swing Nozzle	138 mm
Neoperl Aerator Water Flow	Available in 2.11 GPM (8 LPM) or 3.96 GPM (15 LPM) Options
Temperature Control	Single-handle Dual-control Hot and Cold Adjustment
Hole Size	Φ32-35 mm

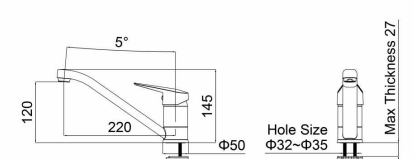

Unit (mm)

## BWSMIX

Deck Mount Manual Faucet with Lever Handle

Attributes	Details
Swing Nozzle	220 mm
Neoperl Aerator Water Flow	Available in 2.11 GPM (8 LPM) or 3.96 GPM (15 LPM) Options
Temperature Control	Single-handle Dual-control Hot and Cold Adjustment
Hole Size	Φ32-35 mm