



BESTWARE Hardware Production Co., Ltd.

Add: Block 8, No.6, Jianda Nan Road, Jiangmen, Guangdong, China

Website: www.bestware-stainless.com

Email: business@bestware-stainless.com after-sales@bestware-stainless.com

WhatsApp: +86 18929047065 Tel: +86 750 3108801

Wechat: +86 18929047065



Website



YouTube



WhatsApp



Wechat

2025 V1.0



European Standard Style Pre Rinse Faucet (without Add-on Swing Nozzle)

User and Installation Manual



PREMIER SOLUTION PROVIDER OF ONE-STOP STAINLESS COMMERCIAL FAUCETS

1. Function Overview

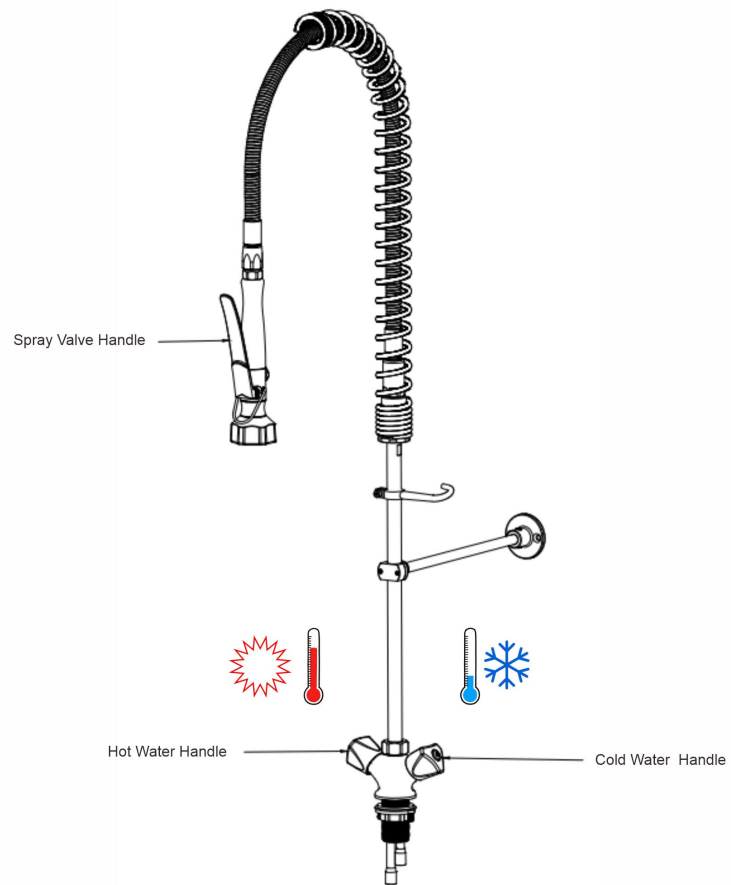

2. Operating Instructions

- 1 Open the hot and cold handles on the body to adjust the water flow and control the temperature.

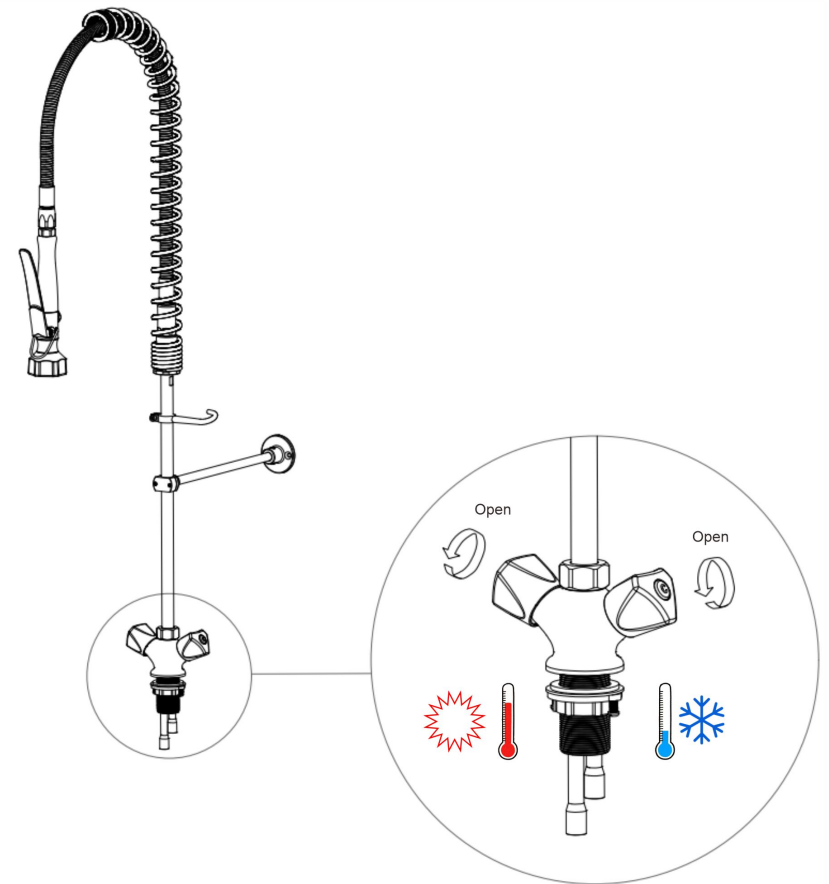

- 2 Use the Spray Valve for Rinsing: Press the handle for water flow. Lock the handle with the hold down ring for continuous flow.

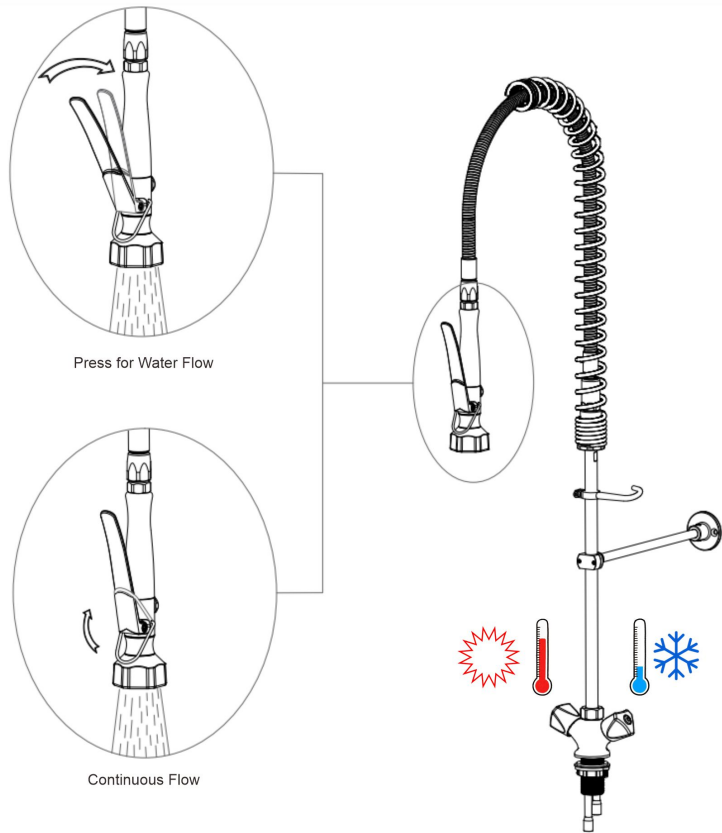

- 3 Switch Flow Modes: Rotate the spray valve head to change the flow mode.

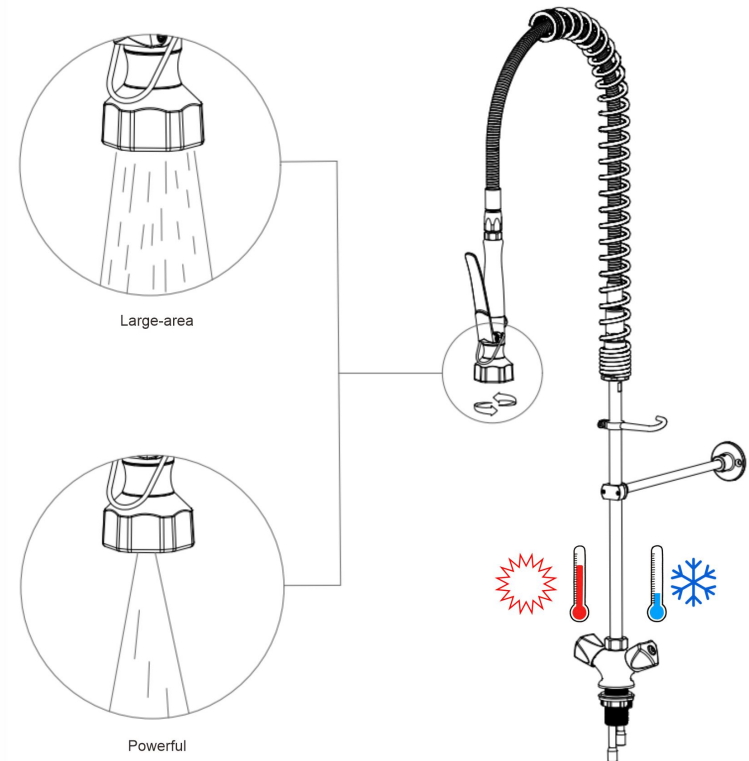

- 4 Move the spray valve left or right to control the swing range.

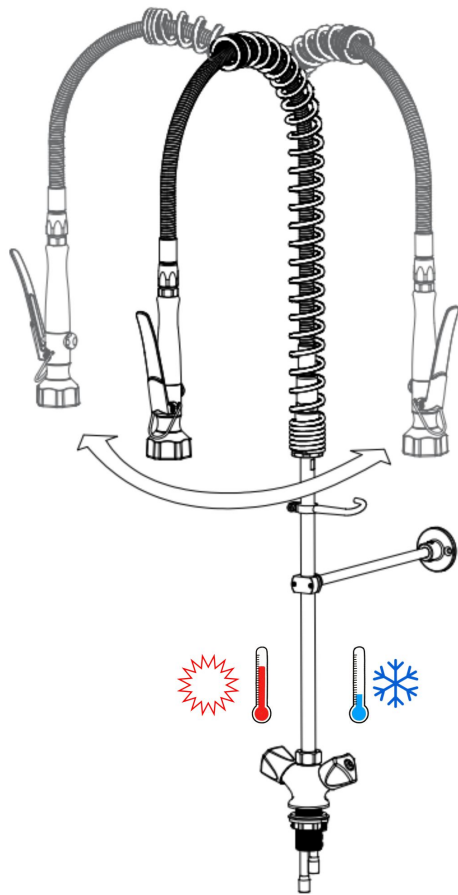

3.Product Structure

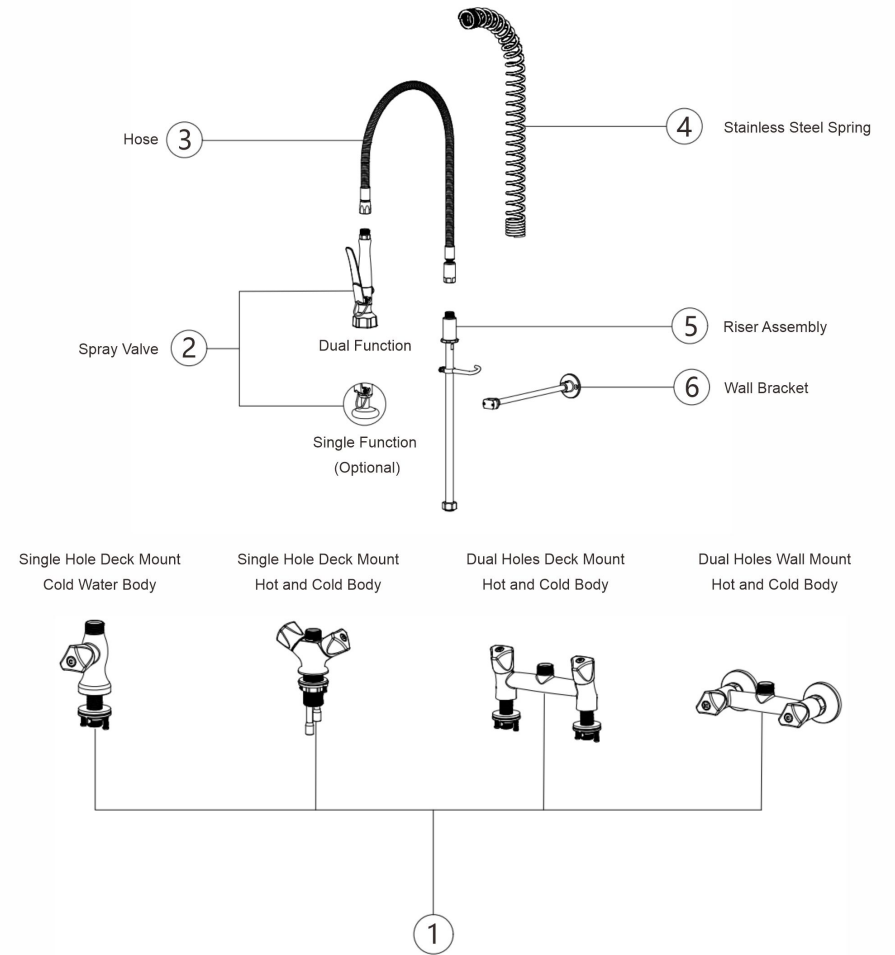

4.Assembly Components

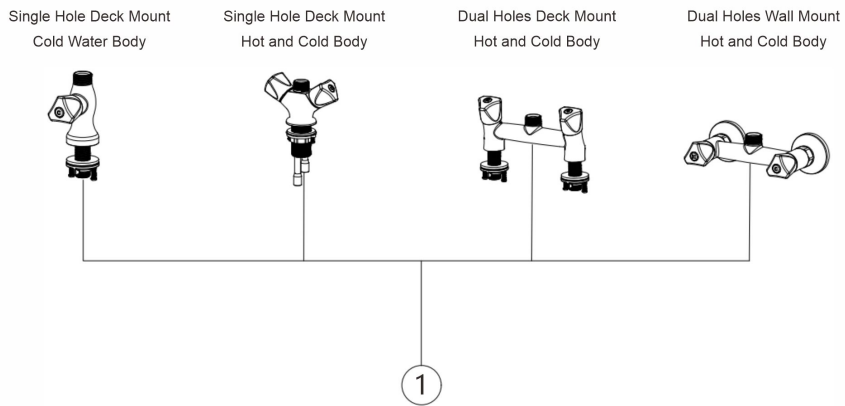
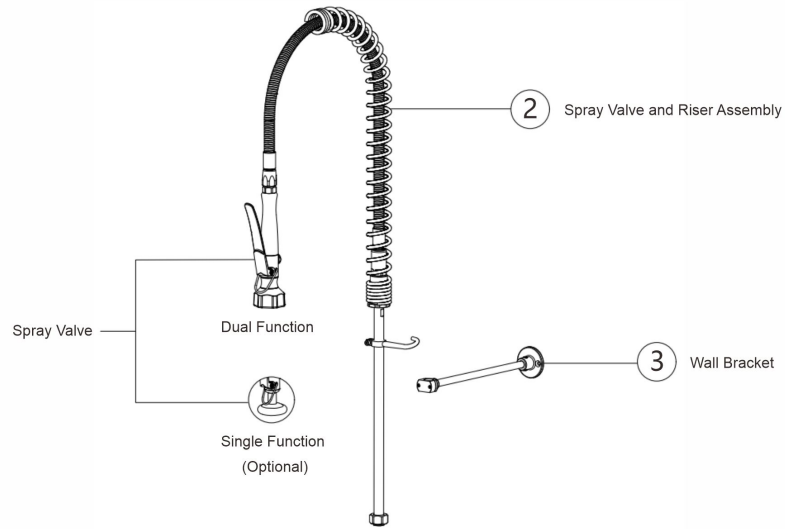

5.Tools Required

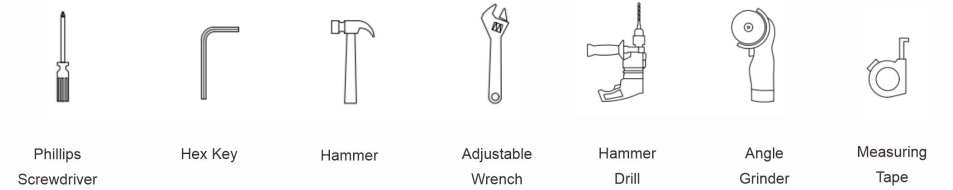

6.Installation Procedure

- Secure the Body: Drill the mounting hole(s) according to the size of the body. Place the body into the hole, install the under-counter nut, and tighten the cross screw. (For dual-hole wall-mount hot and cold body, use a wrench to tighten the nuts.)

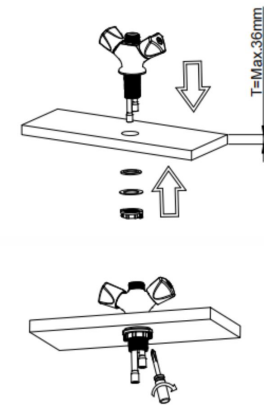
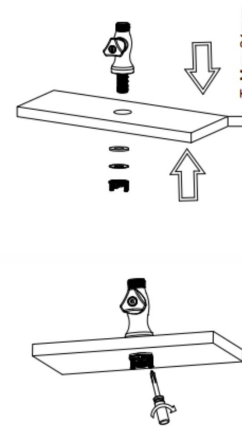
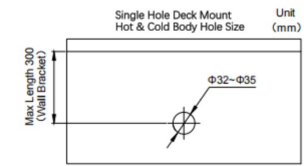
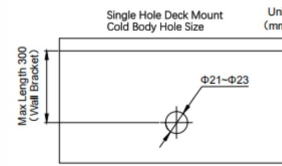

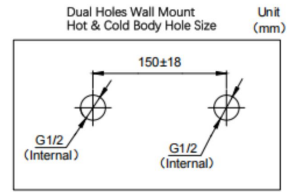
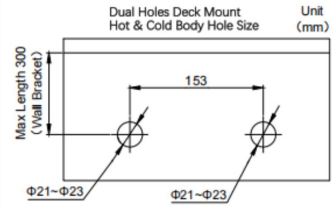

Wrap PTFE Tape Around the End of the Wall Mounted Elbow

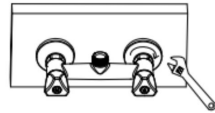
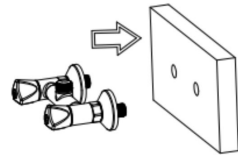
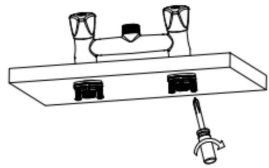
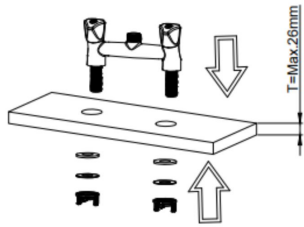
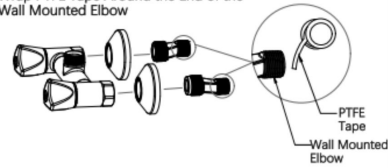

- 2 Wall Bracket Installation: Pre-assemble the spray valve and riser assembly, then measure the required distance from the center of the riser to the wall. Cut the wall bracket rod to the appropriate length, install the base and secure the in-wall screws, then insert the wall bracket rod into the base and tighten the screws.

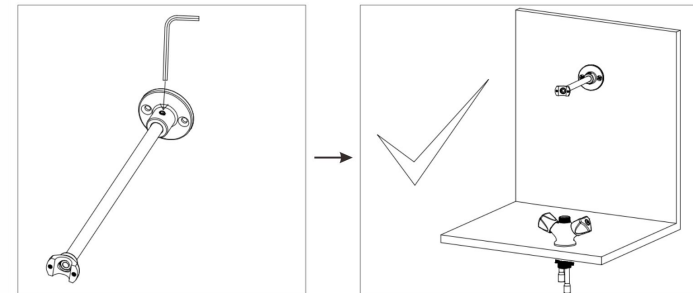
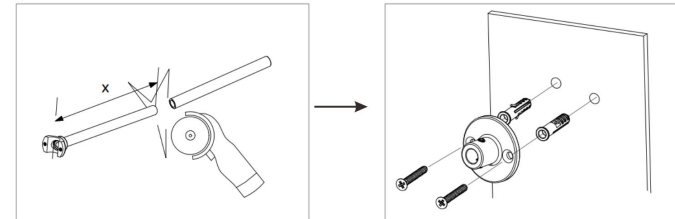
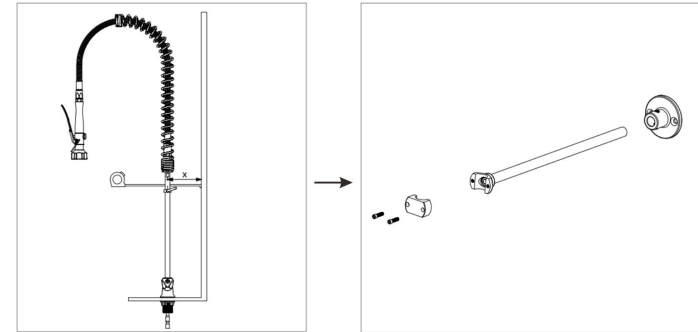

- 3 Install the Spray Valve and Riser Assembly: Align the spray valve and riser assembly with the body and insert it, then tighten the nut with a wrench.

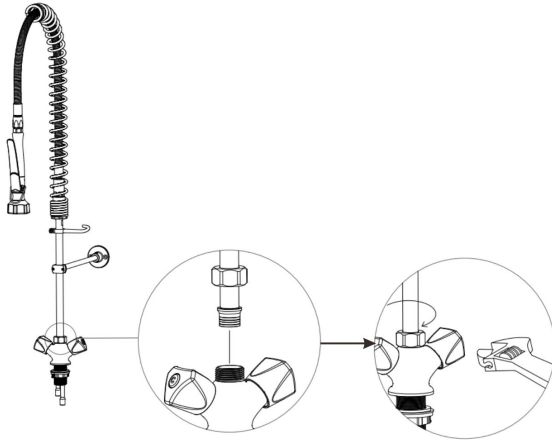

- 4 Secure the Riser with the Wall Bracket: Install the wall bracket fittings and tighten the screws to secure the riser.

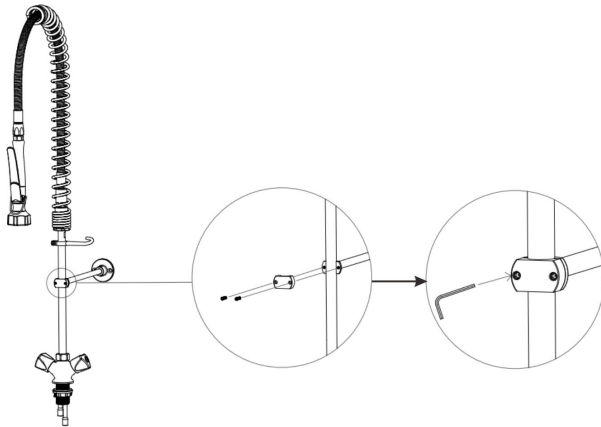

- 5 Connect the Hot and Cold Inlet Tubes: Connect the hot water tube to the left and the cold water tube to the right, then tighten with a wrench. Open the angle valves and check for any leakage in the tubing.

