



BESTWARE Hardware Production Co., Ltd.

Add: Block 8, No.6, Jianda Nan Road, Jiangmen, Guangdong, China

Website: www.bestware-stainless.com

Email: business@bestware-stainless.com after-sales@bestware-stainless.com

WhatsApp: +86 18929047065 Tel: +86 750 3108801

Wechat: +86 18929047065



Website



YouTube



WhatsApp



Wechat

2025 V1.0



American Mini Style Pre Rinse Faucet (with Add-on Swing Nozzle) User and Installation Manual



AS106C



AA106C



AW806C



AD106C

PREMIER SOLUTION PROVIDER OF ONE-STOP STAINLESS COMMERCIAL FAUCETS

1. Function Overview

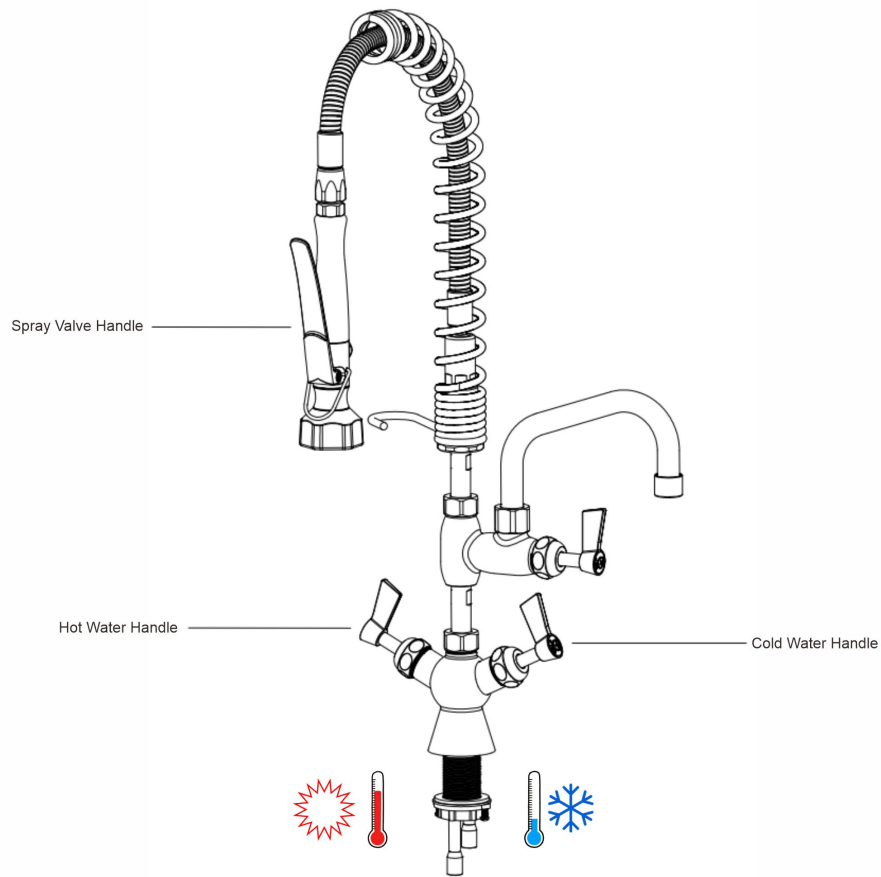

2. Operating Instructions

- 1 Open the hot and cold handles on the body to adjust the water flow and control the temperature.

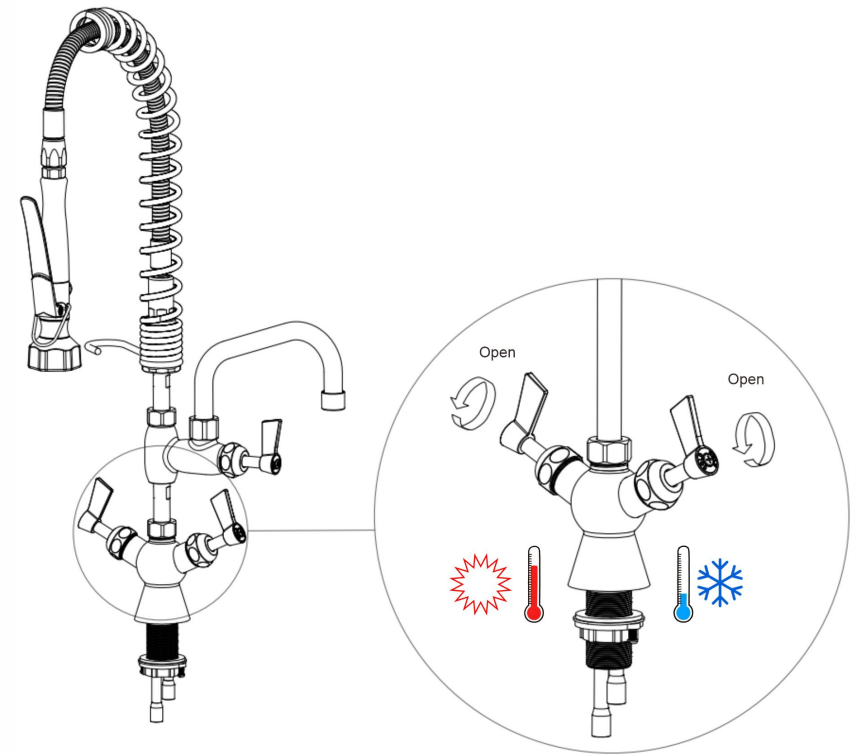

- 2 Use the Spray Valve for Rinsing: Press the handle for water flow. Lock the handle with the hold down ring for continuous flow.

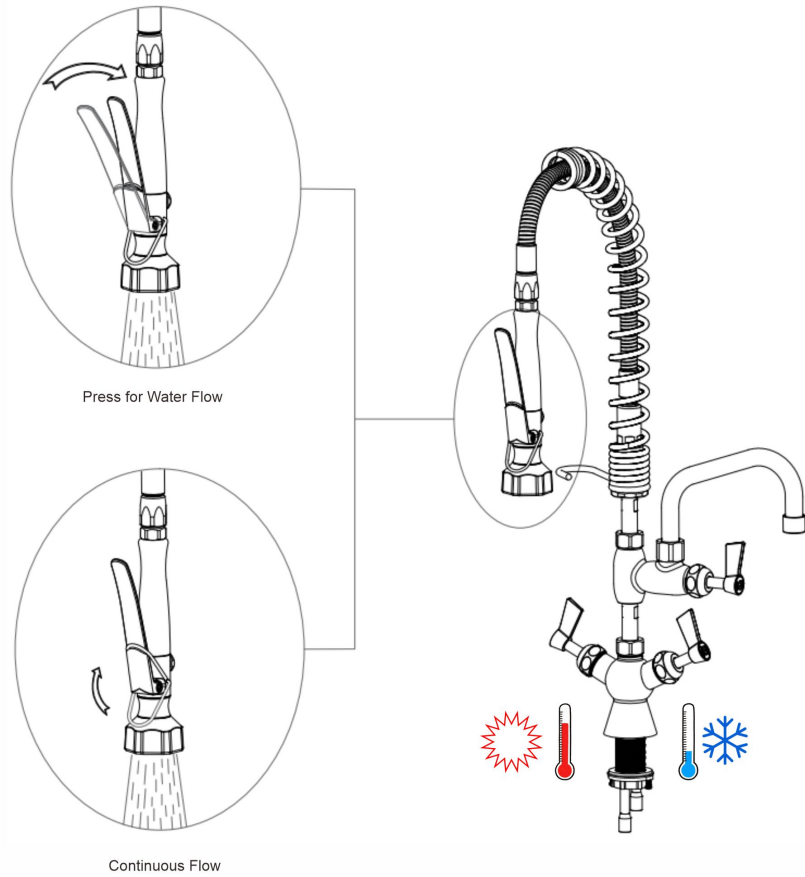

- 3 Switch Flow Modes: Rotate the spray valve head to change the flow mode.

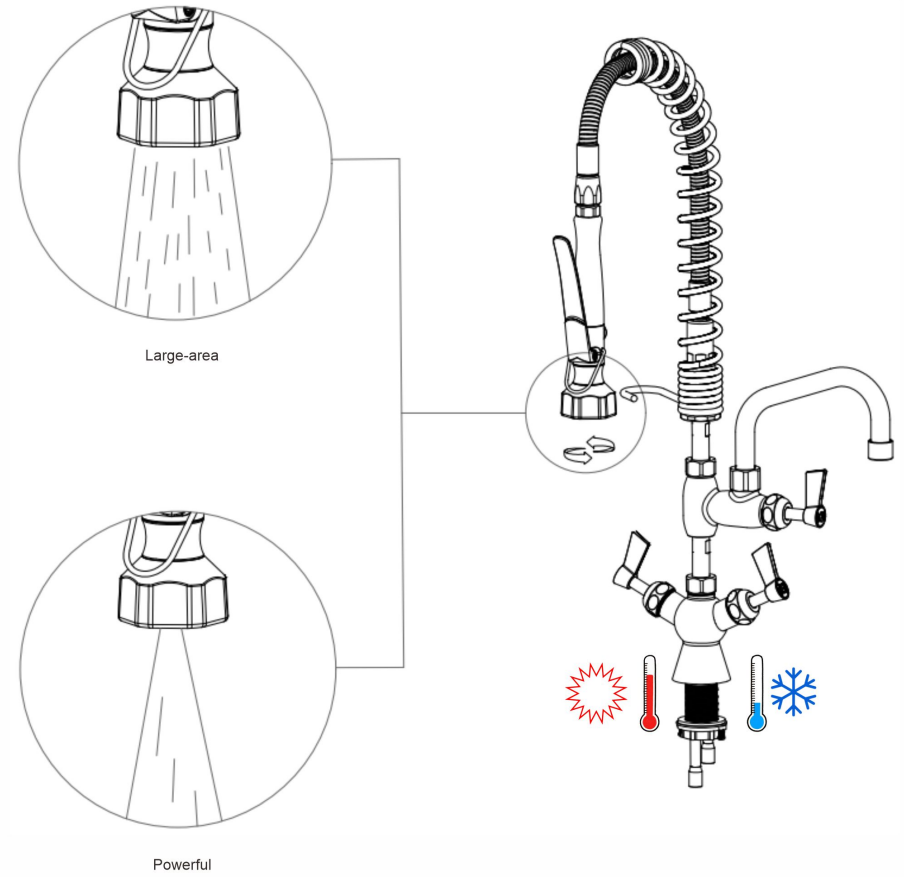

- 4 The add-on swing nozzle handle allows you to adjust the water flow of the swing nozzle.

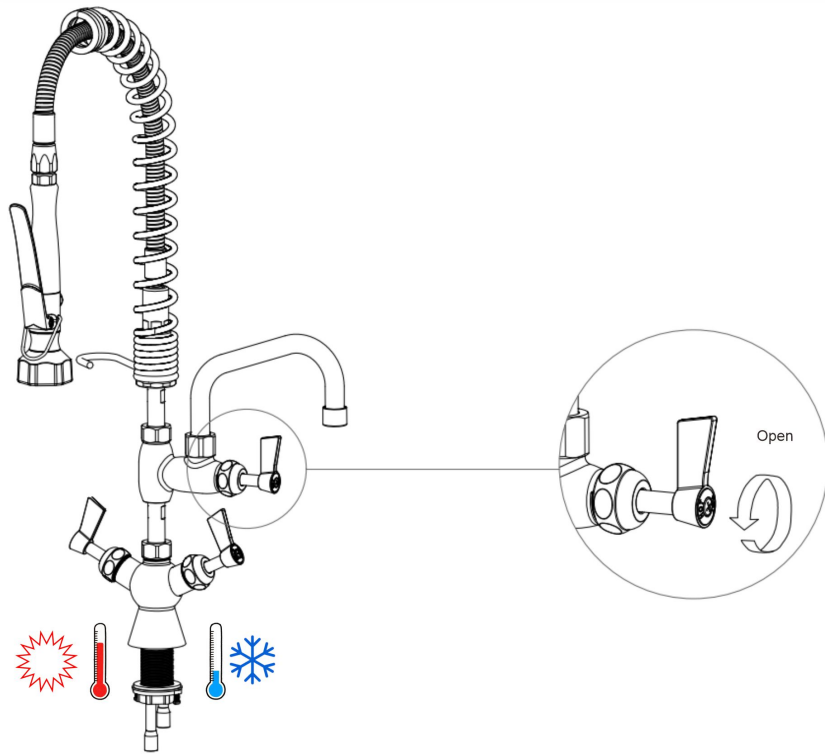

- 5 Move the add-on swing nozzle to adjust the water coverage range.

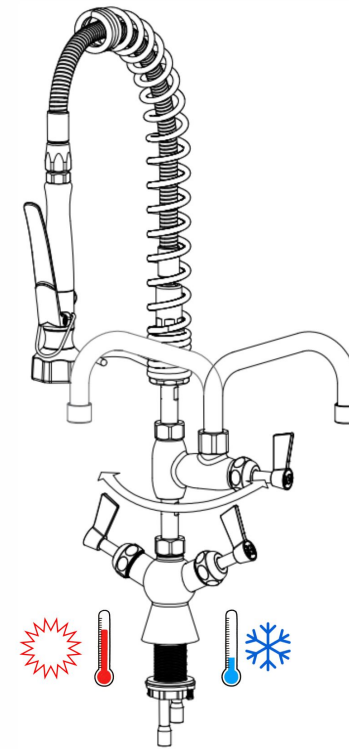

- 6 Move the spray valve left or right to control the swing range.

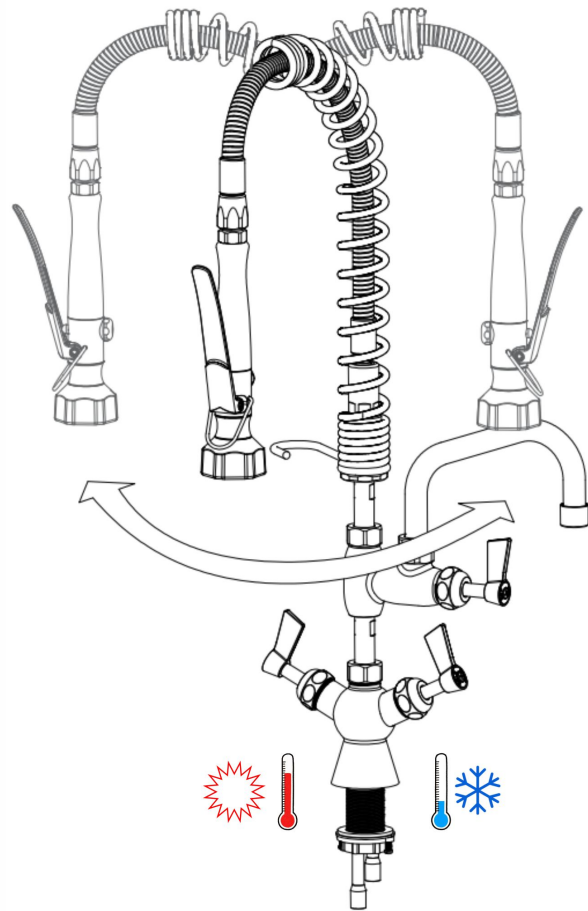

3.Product Structure

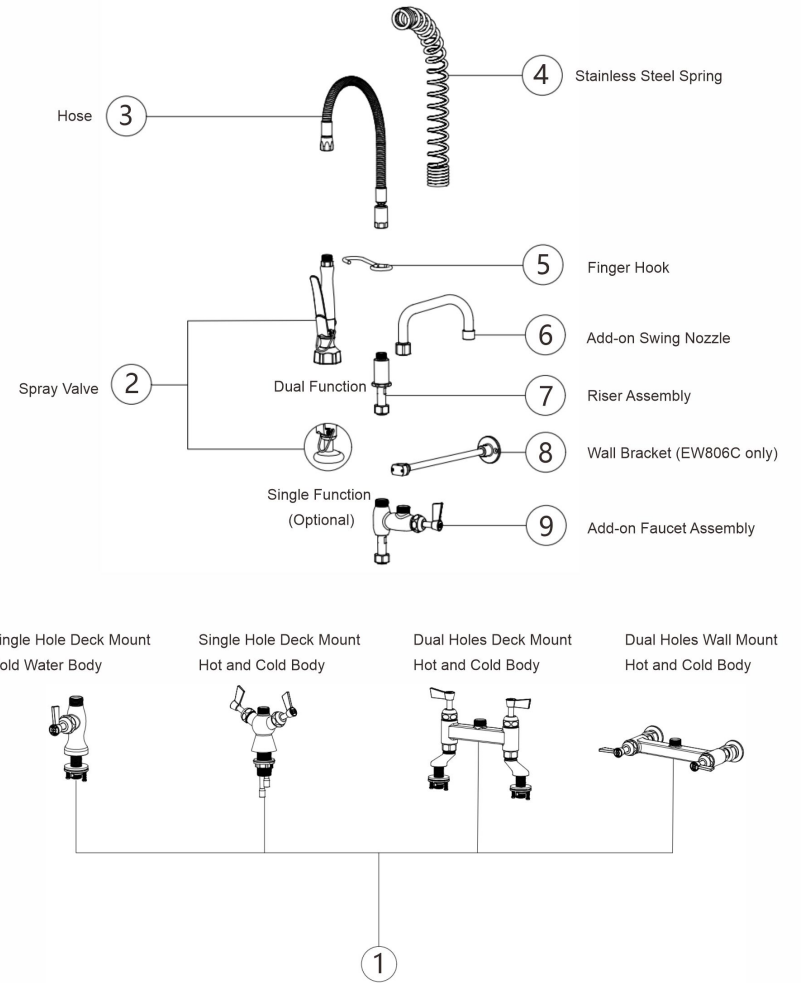

4. Assembly Components

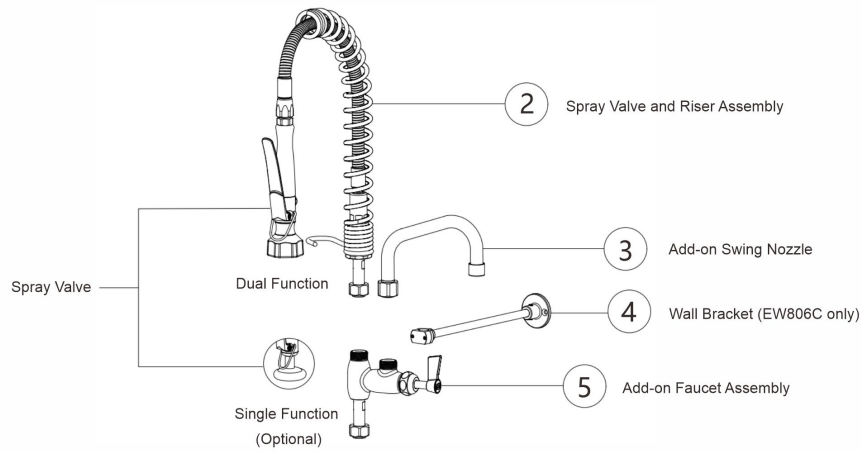

Single Hole Deck Mount Cold Water Body Single Hole Deck Mount Hot and Cold Body Dual Holes Deck Mount Hot and Cold Body Dual Holes Wall Mount Hot and Cold Body

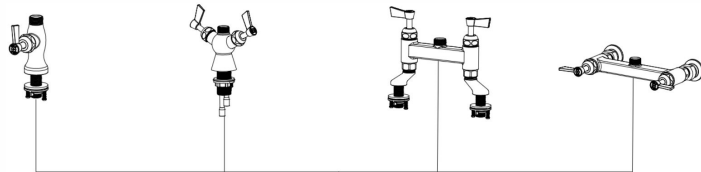

1

5. Tools Required

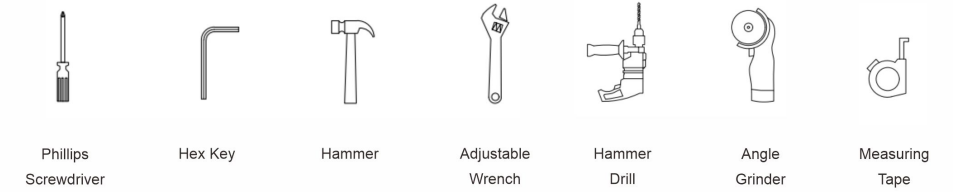

6. Installation Procedure

- Secure the Body: Drill the mounting hole(s) according to the size and position of the body. Place the body into the hole, install the under-counter nut, and tighten the cross screw. (For dual-hole wall-mount hot and cold body, use a wrench to tighten the nuts.)

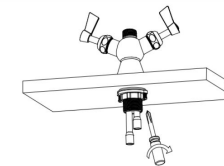
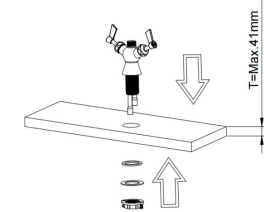
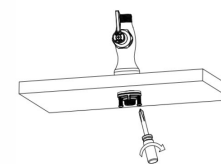
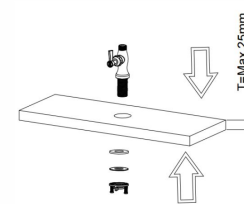
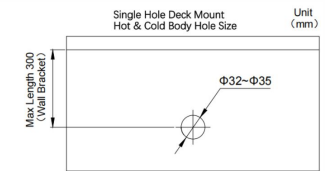
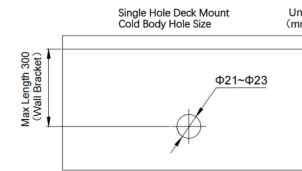

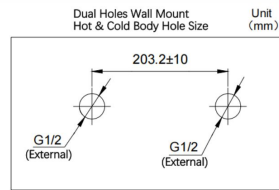
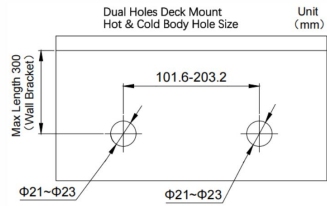

Assemble the Wall Mount Connectors

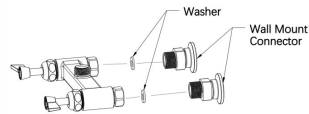

Wrap PTFE Tape Around the Threaded Pipe

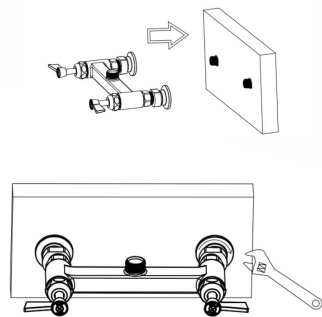
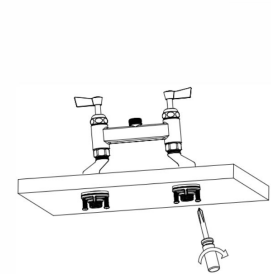
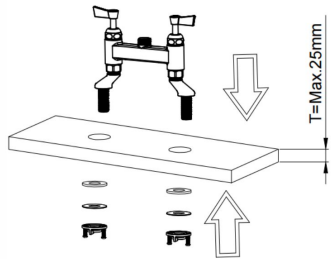
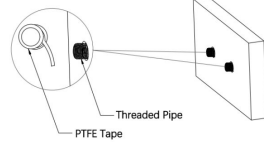

- 2 Wall Bracket Installation (for model AW806C only): Pre-assemble the spray valve and riser assembly, then measure the required distance from the center of the riser to the wall. Cut the wall bracket rod to the appropriate length, install the base and secure the in-wall screws, then insert the wall bracket rod into the base and tighten the screws.

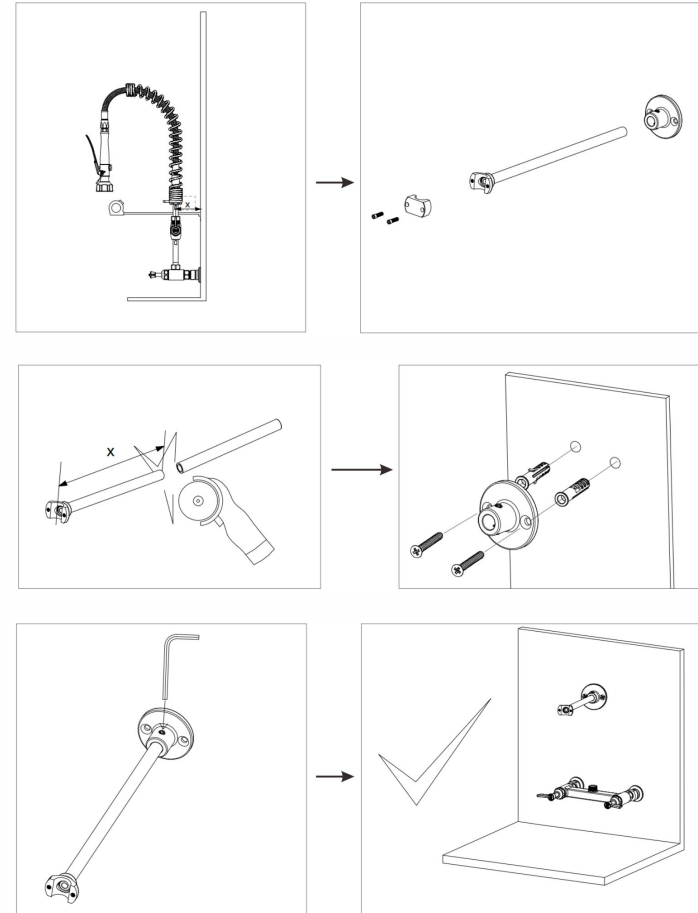

- 3 Install Add-on Faucet Assembly & Spray Valve and Riser Assembly: Insert the add-on faucet assembly into the body and tighten the nut with a wrench. Then insert the spray valve and riser assembly and tighten the nut with a wrench.

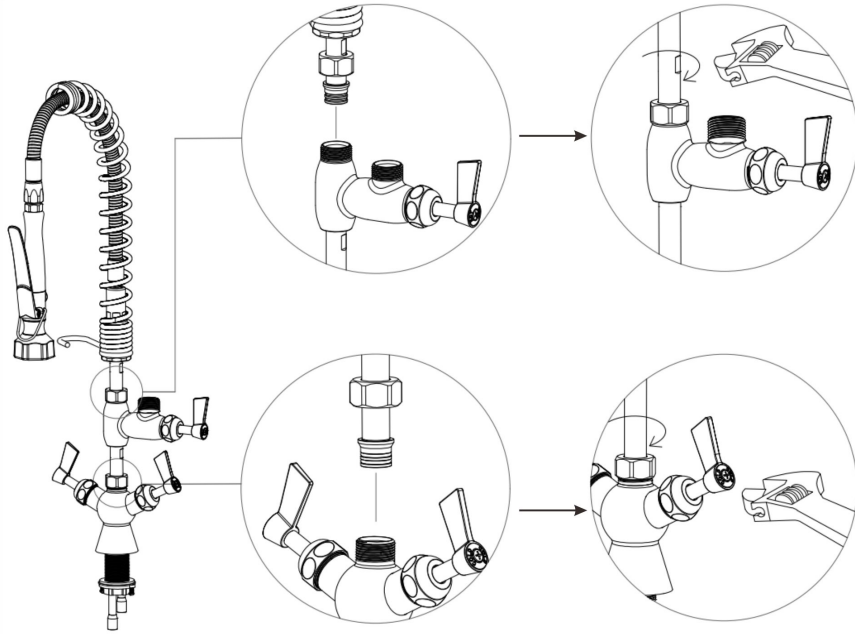

- 4 Secure the Riser with the Wall Bracket (for model AW806C only): Install the wall bracket fittings and tighten the screws to secure the riser.

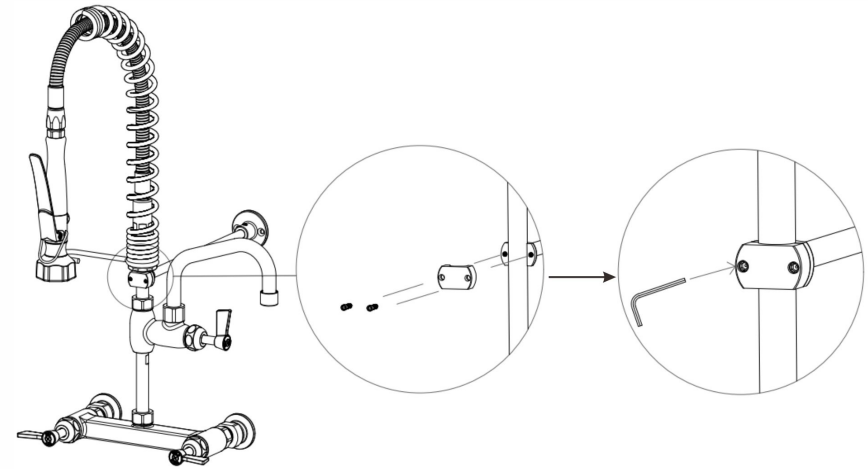

- 5 Connect the Hot and Cold Inlet Tubes: Connect the hot water tube to the left and the cold water tube to the right, then tighten with a wrench. Open the angle valves and turn on the hot and cold handles to check for any leaks in the tubing. Press the spray valve to run water and switch between spray modes to ensure proper functionality.

